

# Resource authorization in IMS with known multimedia service adaptation capabilities

Tomislav Grgic, Vedran Huskic, and Maja Matijasevic

University of Zagreb, Faculty of Electrical Engineering and Computing,  
Unska 3, HR-1000 Zagreb, Croatia  
tomislav.grgic@fer.hr, vedran.huskic@fer.hr, maja.matijasevic@fer.hr

**Abstract.** The Quality of Service (QoS) mapping in Internet Protocol (IP) based networks is not well-suited for complex multimedia services in a dynamically changing service environment and service adaptation driven by such changes. The work presented in this paper is motivated by the challenge to utilize additional knowledge about the service and its adaptation capabilities, in form of the Media Degradation Path, in the signaling across Diameter interfaces related to resources authorization within the Third Generation Partnership Project (3GPP) IP Multimedia Subsystem (IMS). The proposed approach extends the functionality of current Diameter Rx and Gx applications in IMS, and illustrates it by using an adaptive video call service as an example.

## 1 Introduction

Quality of service (QoS) assurance for networked multimedia services requires coordination of resources and quality control mechanisms at all points in the system. The mechanisms operating at the multimedia service level (responsible for requesting, authorizing, monitoring, and controlling service-specific QoS parameters), must work together with the network level QoS mechanisms, which are generic and application-independent. In the 3GPP IP Multimedia Subsystem (IMS) [1], a framework for QoS mapping is applied within the Policy Control and Charging (PCC) architecture [2] and related to signaling flows between the entities in the PCC architecture [3]. The signaling protocol used in PCC for this purpose is Diameter [4].

As the richness and variety of next-generation multimedia services increases, so does the amount and complexity of QoS related signaling between the service and network layers, giving rise to questions regarding signaling scalability [5]. The way of QoS mapping and network resources negotiation in IP-based networks, including IMS-based ones, is well-established (at least theoretically) and fairly straightforward: from session parameters to IP QoS to access network specific QoS class. This model, however, is not well-suited for complex multimedia services in service environments with many possible dynamic changes (e.g., triggered by user preferences, terminal capabilities, current network conditions), and service adaptation driven by such changes. The work presented in this paper is motivated by the challenge to utilize additional knowledge about the service

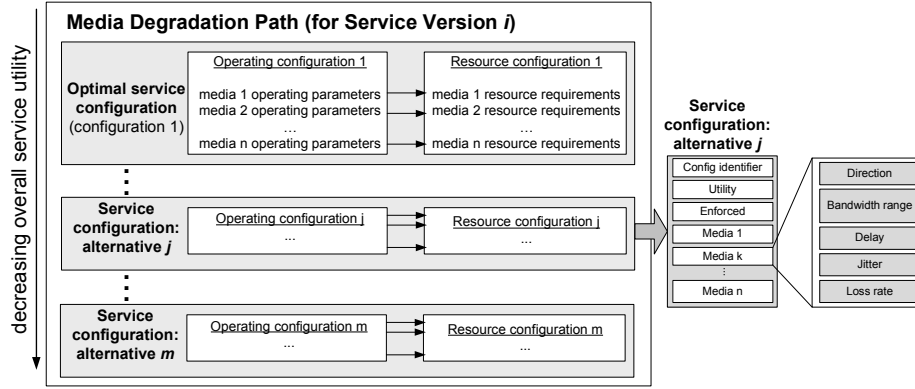

Fig. 1. Media Degradation Path

and its adaptation capabilities within the PCC architecture in IMS to make the process more flexible, and hopefully reduce the number of steps (and the time) in which the successful authorization of network resources could be achieved.

The paper is organized as follows. Section 2 describes the idea of introducing knowledge about the application in the QoS negotiation process. Section 3 provides an overview of the relevant reference points in IMS PCC based on Diameter protocol and proposes how they could be extended to support the proposed idea. Section 4 presents an example using a video call service.

## 2 Knowledge about adaptation capabilities of a multimedia service

From the network provider's point of view, a multimedia service is a (set of) combination(s) of two or more *media components* (e.g., audio, video, 3D graphics) within a particular network environment providing that service. Considering that a multimedia service is composed of one or more media components, we specify *service versions* as initially differing in the included media components (e.g., Version 1 for desktop computer with streaming media, Version 2 without streaming media for a handheld computer or a mobile phone). Each media component may be configured by choosing from a set of offered alternative *operating parameters* (e.g., different codecs, frame rates, resolutions, etc.). For a particular service version, we refer to the overall *service configuration* as the set of chosen operating parameters across all included media components (flows). The one active configuration at any one time is marked as "enforced". In the process of QoS provisioning, operating parameters are mapped to QoS parameters, followed by network resources authorization and reservation. In our previous work, we proposed a model for dynamic service adaptation (DSAM) [6] and its application in IMS [7]. The QoS matching and optimization process in DSAM is based on including a list of possible service configurations, ranked by utility, into

the exchange of data in the QoS negotiation proces. This list, named “Media Degradation Path” (Fig. 1) represents the application-specific knowledge about the capability of the service to adapt to varying user preferences, terminal capabilities, service requirements, and available resources in the access network. Each configuration specifies the list of network requirements to be fulfilled for the configuration to be enforced. The requirements are divided into groups of media flows, each of them specifying direction (uplink or downlink), flow description (source/destination IP addresses and ports), bandwidth limitations and QoS parameters.

### 3 Extending the relevant Diameter applications in IMS

Diameter base protocol was initially specified by the Internet Engineering Task Force (IETF) [4] and adopted by 3GPP for use in IMS. Diameter provides a framework for authentication, authorization and accounting (AAA). Diameter architecture consists of Diameter base protocol and Diameter applications (Fig. 2). The base protocol provides only fundamental AAA capabilities, such as negotiating capabilities and error handling. Diameter applications extend the base protocol by defining application-specific messages and parameters. A Diameter message consists of a Diameter header, followed by information elements called attribute-value pairs (AVPs). An AVP may be of a primitive value type (e.g., Integer, String), and a “Grouped” value type containing other AVPs. This approach allows building new Diameter applications by adding new AVPs and composing new messages by using existing or new AVPs. Diameter Base Protocol messages referred to in this work are: Re-Authentication-Request/-Answer (RAR/RAA), and Session-Termination-Request/-Answer (STR/STA).

How the current Diameter applications over of the Rx [8] and the Gx [9] reference points could be extended in order to include the knowledge about the service contained within the MDP is described next. (Some familiarity with the IMS architecture is assumed; an interested reader is referred to [1] for more details.) Figure 3 shows the QoS mapping across the Gx and Rx reference points in IMS PCC architecture [3]. We assume that the selected service configuration and the MDP are signaled by using the Session Initiation Protocol (SIP). The Rx reference point is used for transporting session-related information from the Proxy-Call Session Control Function (P-CSCF) to the Policy Control and

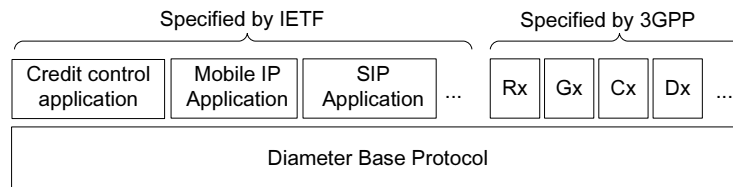

**Fig. 2.** Diameter Architecture

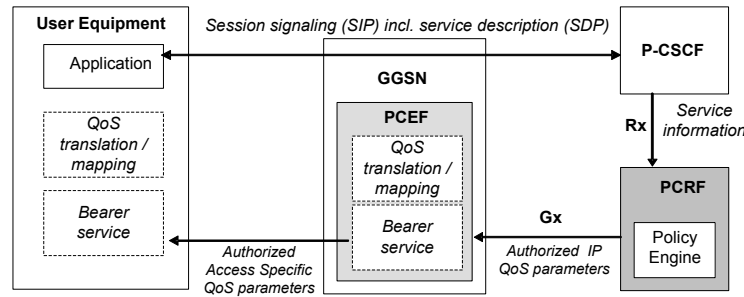

Fig. 3. QoS Mapping

Charging Rules Function (PCRF) in order to reserve resources in the connectivity layer needed for session establishment. Session information may be received from the P-CSCF due to initial session establishment, session modification, or session termination. The PCRF provides network control regarding service data flow detection, gating, QoS and flow-based charging towards the PCEF. It is also responsible for informing the P-CSCF of events in the connectivity layer, e.g. change in network resources. The PCRF may use subscription-specific information as a basis for the policy and charging control decisions, e.g. the highest allowed QoS class, or, maximum bit rate. The Gx reference point enables the PCRF to dynamically control the Policy and Charging Enforcement Function (PCEF). Depending on the collected session and subscriber-specific information, the PCRF issues Policy Control and Charging (PCC) rules. The Gx is also used for provisioning and removing the PCC rules from the PCRF to the PCEF and the transmission of connectivity layer events from the PCEF to the PCRF. In an UMTS RAN, PCEF is situated at the GPRS Gateway Support Node (GGSN), providing control over the connectivity layer traffic, reserving network resources needed for service establishing and delivery, and performing online and offline charging. Diameter messages of interest in this paper include base protocol messages mentioned earlier, as well as additional Rx and Gx application-specific messages: Authentication-Authorization-Request/Answer (AAR/AAA), and Control-Charging-Request/Answer (CCR/CCA).

### 3.1 Rx Diameter application

In order to use the information stored in MDP for the PCC decision/making procedure, new MDP-specific AVPs are introduced and integrated in existing Rx application messages. Table 1 lists all (proposed) MDP-specific AVPs and selected Rx application AVPs relevant for this model. The MDP data is mapped to a group of Diameter AVPs using MDP-Configuration AVP, shown in Fig. 4. MDP-Configuration is of type Grouped. SIP-Item-Number presents a configuration identifier in a MDP, MDP-Utility stores information about the configuration utility, and MDP-Enforced AVP marks whether this configuration is enforced (or not) at the connectivity layer. Each configuration contains a number of MDP-

**Table 1.** MDP-specific and selected Rx application AVPs

Attribute name	Value type
MDP-Configuration	Grouped
MDP-Utility	Float
MDP-Enforced	Enumerated
MDP-Media	Grouped
MDP-Media-Delay	Integer
MDP-Media-Jitter	Integer
MDP-Media-Loss	Integer
MDP-Media-Max-Bandwidth	Integer
MDP-Media-Min-Bandwidth	Integer
Session-Id	String
Flow-Description	Grouped
Flow-Usage	Enumerated
SIP-Item-Number	Integer

Media AVPs, defining bandwidth, network QoS parameters and flow description (source and destination IP addresses, ports, and transport protocols) for each media flow. Depending on the number of configurations in MDP, one or more MDP-Configuration AVPs may be included in a Diameter message.

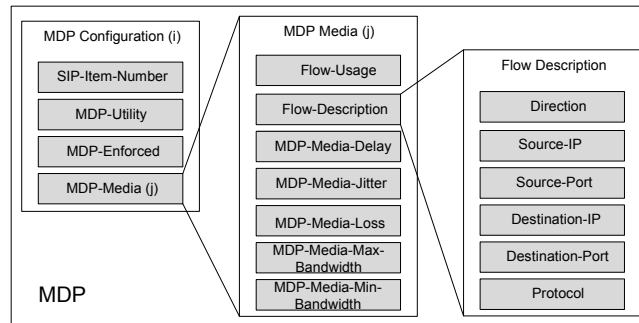
**Fig. 4.** Assigning data contained in MDP to AVPs

### 3.2 Gx Diameter application

The MDP-specific AVPs for the Rx interface, described in the previous section, are reused for QoS parameters description for the Gx interface. Table 2 lists Gx application-specific AVPs which had to be extended with MDP-specific AVPs addressing network QoS parameters such as delay, jitter, loss rate, and bandwidth. Figure 5 shows how MDP may be included in a PCC rule. Charging-Rule-Install AVP is used to activate, install or modify PCC rules as instructed

**Table 2.** Modified Gx application-specific AVPs

Attribute name	Value Type
Charging-Rule-Install	Grouped
Charging-Rule-Remove	Grouped
Charging-Rule-Definition	Grouped
Authorized-QoS	Grouped

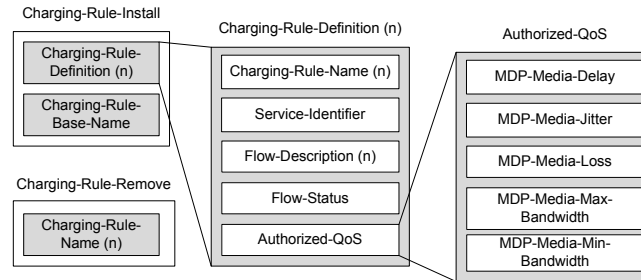
**Fig. 5.** Structure of Gx specific AVPs

from the PCRF to the PCEF. The Charging-Rule-Remove AVP is used to deactivate or remove existing PCC rules. Each PCC rule contains a unique identifier stored in Charging-Rule-Name AVP. For each media flow specified in the selected configuration, a separate PCC rule is created.

### 3.3 Prototype implementation

In the course of this work, we developed a prototype implementation of the extended Diameter Rx and Gx applications based on Open Diameter. Open Diameter ([www.opendiameter.org](http://www.opendiameter.org)) is an open source implementation of the Diameter Base Protocol in the C++ programming language. We extended the existing implementation by adding MDP support for Rx and Gx Diameter applications. Our next step is performance evaluation.

## 4 Example: An adaptive video call service

The proposed model of MDP support in Rx and Gx reference points is illustrated by an adaptive video call service as follows. A user initiates a video call session to his colleague by using a softphone on his desktop computer in the office. Table 3 presents an example of received MDP for the negotiated video call. Each media component may be described by unique MDP\_Media AVP, containing all QoS parameters and flow descriptions. At some point, he needs to leave for the meeting, yet wants to use the time while on the way to continue the conversation. According to his preferences, the video call is transferred without interruption to his mobile phone as he leaves the office. Once he gets to the car, he activates his hands-free set, and the video component is turned off. Finally, the session is terminated.

**Table 3.** MDP for video call service

Configuration	Video codec, frame size	Audio codec	Utility
Config 1	H.263, 640x480 pixel	PCM	0.8
Config 2	H.263, 320x240 pixel	GSM	0.6
Config 3	–	GSM	0.3

#### 4.1 Session establishment

For a new video call session establishment in the IMS signaling plane, resources in the connectivity layer must be reserved for the session. Once the session is successfully negotiated in the signaling plane, the P-CSCF receives a SIP message containing the MDP of the negotiated service (Figure 6). The P-CSCF receives a new SIP message containing MDP to be applied (1), and collects MDP data and creates new MDP-Configuration AVPs (2). It then sends a Diameter AAR message containing all MDP information to the PCRF (3), which stores the received service information (4). Next, the PCRF selects configuration with the highest utility, Config 1 (5), and creates one PCC rule per each media component in it (6). It then sends a new Diameter Re-Auth-Request (RAR) message to the PCEF (7). Depending on the received rules, PCEF is able to install, remove, or modify PCC rules. In this case, reservation of network resources for configuration Config 1 is performed (8). The PCEF informs the PCRF of the successful or unsuccessful application of PCC rules by

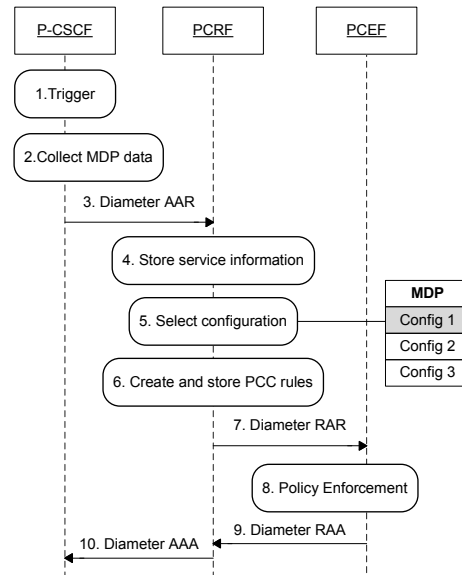
**Fig. 6.** Session establishment scenario

PCEF, containing all PCC rules to be applied (7). Depending on the received rules, PCEF is able to install, remove, or modify PCC rules. In this case, reservation of network resources for configuration Config 1 is performed (8). The PCEF informs the PCRF of the successful or unsuccessful application of PCC rules by

sending a Re-Auth-Answer (RAA) Diameter message (9). The PCRF stores the information of successful reservation by setting MDP-Enforced value of Config 1 to *true* and sending the AAA Diameter message to the P-CSCF containing the applied configuration (10).

## 4.2 Network resources modification

Change in network resources may lead to enforcing another configuration in the MDP, for example, when the video call session is switched to a mobile phone (Fig. 7). The PCEF detects the decrease of available bandwidth for video (1).

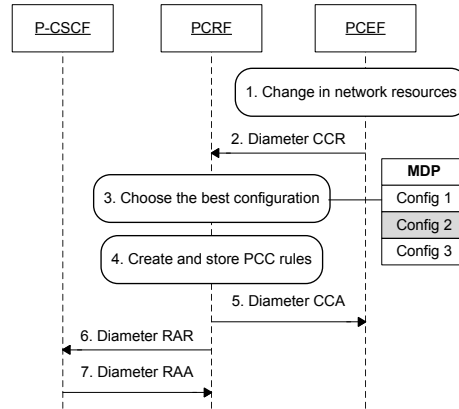

Fig. 7. Network resources modification

The PCEF sends a Diameter Charging-and-Control-Request (CCR) containing information about currently available bandwidth to PCRF via Gx interface (2). The PCRF chooses the highest utility configuration specified in the MDP, based on available bandwidth, here, the Config 2 (3). The PCRF creates new PCC rules depending on the chosen configuration (4) and sends a Diameter CC-Answer to the PCEF containing new PCC rules to be applied (5). The PCRF informs P-CSCF of the configuration change by sending a Diameter RAR. MDP-Configuration AVP is used, setting the MDP-Enforced value to true for Config 2 (6). The P-CSCF responds by sending a Diameter RA-Answer (7).

## 4.3 Service requirements modification

This scenario takes place when the trigger for switching to another configuration comes from the user or application server, as shown in Fig. 8. When the user in the video call gets to the car, the video component is stopped and the call continues with the audio component only. The P-CSCF receives a SIP message containing a reference to the Config 3 in the MDP (1). The P-CSCF sends a Diameter AA-Request to the PCRF containing the received reference (2). The



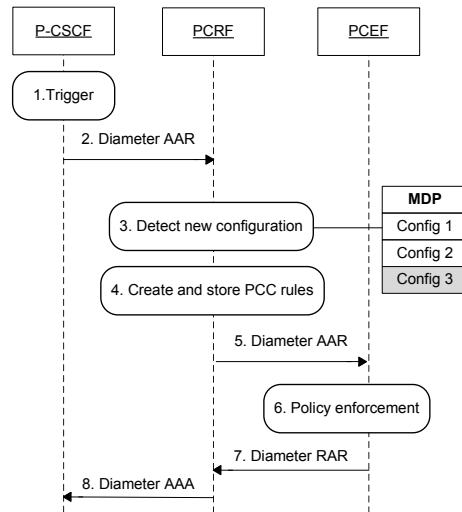

**Fig. 8.** Service requirements modification

PCRF extracts Config 3 from MDP (3), creates new PCC rules based on the new configuration (4), and sends new PCC rules to the PCEF (4). The PCEF modifies resources for the audio component, while the resources for the video component are released (5). The PCEF informs the PCRF about the successful resources reservation (6). The PCRF informs the P-CSCF about the successful configuration enforcement (7).

#### 4.4 Session termination

Fig. 9 shows a session termination scenario. The P-CSCF receives a session termination request (1), and sends a Session-Termination-Request (STR) to the PCRF (2). The PCRF erases all existing PCC rules as well as the current MDP (3), and it issues an Re-Auth-Request (RAR) with instruction to remove all PCC rules for the required session (4). The PCEF removes all PCC rules and releases all previously reserved resources (5), and sends a Re-Auth-Answer (RAA) to PCRF to confirm successful release of resources (6). The PCRF sends a Session-Termination-Answer (STA) to P-CSCF, thus completing the process (7).

## 5 Conclusions and future work

In this work we proposed a model of including a set of alternative service configuration parameters in the form of a MDP within the process of creating and managing policy-based rules in IMS. A case study was presented, illustrating the practical use of the model. Future work will focus on performance evaluation of the proposed Diameter signaling extensions in line with the Diameter Maintenance and Extensions workgroup recommendations.

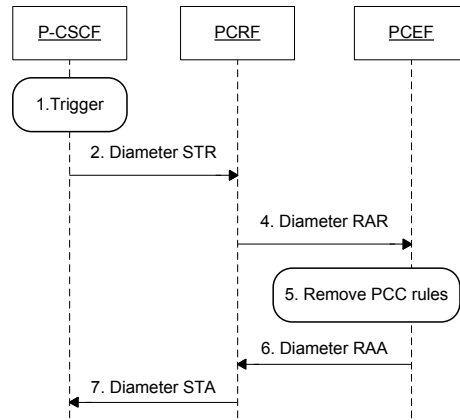

**Fig. 9.** Session termination

## Acknowledgement

The authors gratefully acknowledge the support of the Ministry of Science, Education and Sports of the Republic of Croatia research project no. 036-0362027-1639, and the Ericsson Nikola Tesla ETK-FER Summercamp 2007.

## References

1. Camarillo, G., Garcia Martin, M.A.: The 3G IP Multimedia Subsystem (IMS): Merging the Internet and the Cellular Worlds. John Wiley & Sons (2004)
2. 3GPP: TS 23.203: Policy and charging control architecture, Release 7 (December 2007)
3. 3GPP: TS 29.213 Policy and charging control signaling flows and QoS parameter mapping, Release 7 (June 2007)
4. Calhoun, P., Loughney, J., Guttman, E., Zorn, G., Arkko, J.: Diameter Base Protocol. RFC 3588 (Proposed Standard) (September 2003)
5. Agrawal, P., Yeh, J.H., Chen, J.C., Zhang, T.: IP Multimedia Subsystems in 3GPP and 3GPP2: Overview and Scalability Issues. IEEE Communications Magazine **46**(1) (January 2008) 138–145
6. Skorin-Kapov, L., Matijašević, M.: Dynamic QoS negotiation and adaptation for networked virtual reality services. In: Proceedings of the IEEE WoWMoM, Taormina, Italy (June 2005) 344–351
7. Skorin-Kapov, L., Mosmondor, M., Dobrijevic, O., Matijasevic, M.: Application-level QoS negotiation and signaling for advanced multimedia services in the IMS. IEEE Communications Magazine **45**(7) (July 2007) 108–116
8. 3GPP: TS 29.214 Policy and Charging Control over Rx reference point, Release 7 (January 2007)
9. 3GPP: TS 29.212 Policy and Charging Control over Gx reference point, Release 7 (January 2007)